

SPM-2101WG

(RoHS Compliant)

1310 nm / 10.3 Gb/s Digital Diagnostic LC Multi-Mode SFP+ for 10GBASE-LRM

FEATURES

- I Optical Interface specifications per IEEE 802.3aq 10GBASE-LRM
- I Complaint to SFP+ MSA
- I **Link Distance at 10.3 Gbd**
OM1 MMF Links up to 220 m
OM2 MMF Links up to 220 m
OM3 MMF Links up to 220 m
- I SFF-8472 Digital Diagnostic Function
- I AC/AC Coupling according to MSA
- I Single +3.3 V Power Supply
- I RoHS 6/6 Compliant
- I 0 to 70°C Operation
- I Class 1 Laser International Safety Standard IEC 60825 Compliant

DESCRIPTION

The SPM-2101WG series SFP+ LRM is an optical module for transmission at 1310 nm over legacy multimode fiber up to 220 m. It compliant with SFF-8431, SFF-8432, and IEEE 802.3aq 10GBASE-LRM. It is with the SFP+ 20-pin connector to allow hot plug capability. Digital diagnostic functions are available via an I²C. This module is designed for multi-mode fiber and operates at a nominal wavelength of 1310 nm. The transmitter section uses a 1310 nm FP laser and is a Class 1 laser compliant according to International Safety Standard IEC 60825. The receiver section uses an InGaAs linear multimode PIN receiver. Host board designers using an EDC PHY IC should follow the IC manufacturer's recommended setting for interoperating the host board EDC PHY with a linear receiver SFP+ module.

APPLICATIONS

- I 10GBASE-LRM

LASER SAFETY

This multi-mode transceiver is a Class 1 laser product. It complies with IEC 60825 and FDA 21 CFR 1040.10 and 1040.11. The transceiver must be operated within the specified temperature and voltage limits. The optical ports of the module shall be terminated with an optical connector or with a dust plug.

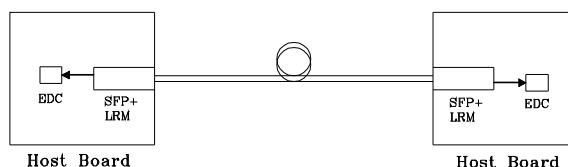

ORDER INFORMATION

P/No.	Bit Rate (Gb/s)	10GBASE	Distance (m)	Wavelength (nm)	Package	Temp. (°C)	RoHS Compliant
SPM-2101WG	10.3	LRM	220*	1310	SFP+ with DMI	0 to 70	Yes

*: 220 m for OM1 MMF, and 220 m for OM2 MMF and 220m for OM3 MMF.

Absolute Maximum Ratings						
Parameter	Symbol	Min	Max	Units	Notes	
Storage Temperature	Tstg	-40	85	°C		
Operating Case Temperature	Topr	0	70	°C		
Operating Relative Humidity	RH	5	95	%	Non condensing	
Power Supply Voltage	Vcc	0	4	V		

Recommended Operating Conditions						
Parameter	Symbol	Min	Typ	Max	Units / Notes	
Power Supply Voltage	Vcc	3.14	3.3	3.46	V	
Operating Case Temperature	Topr	0		70	°C	
Power Supply Current	I _{CC(TX+RX)}		200	300	mA	
Power Dissipation	P			1.0	W	
Data Rate		9.95	10.3125		Gb/s	

Transmitter Optical Specifications (0°C < Topr < 70°C, 3.13V < Vcc < 3.47V)						
Parameter	Symbol	Min	Typ	Max	Units	Notes
Average Launch Power	P _{O, Avg}	-6.5		0.5	dBm	1
Optical Modulation Amplitude	P _{O, OMA}	-4.5		+1.5	dBm	
Output Center Wavelength	λ _c	1260		1360	nm	
Output Spectrum Width	σ _λ			2.4	nm	RMS (σ)
Optical Extinction Ratio	ER	3.5			dB	
Transmitter Waveform Dispersion Penalty	TWDP			4.7	dB	
Average Launch Power of OFF Transmitter				-30	dBm	
Relative Intensity Noise	RIN			-128	dB/Hz	12 dB reflection

1. Average power figures are informative only, per IEEE 802.3aq.

Receiver Optical Specifications (0°C < Topr < 70°C, 3.13V < Vcc < 3.47V)						
Parameter	Symbol	Min	Typ	Max	Units	Notes
Receiver Sensitivity	Sens			-9.9	dBm	3
Stress Sensitivity (OMA)			---	-6.5	dBm	
Stress Sensitivity (OMA), symmetrical test				-6.0	dBm	
Receiver Overload	P _{MAX}	+1.5	---		dBm	
LOS -- Deasserted	LOS _D	---	---	-11	dBm	Transition: low to high
LOS -- Asserted	LOS _A	-30	---	---	dBm	Transition: high to low
Wavelength of Operation	λ _c	1260		1360	nm	
Optical Return Loss	ORL			-12	dB	

3. Measured with worst ER; BER < 10⁻¹² and PRBS 2³¹-1.

Electrical Characteristics						
Parameter	Symbol	Min	Typ	Max	Units	Notes
High-Speed Signal (CML) Interface Specification						
Input Data Rate			10.3125	10.5	Gb/s	
Differential Input Impedance	R _{in}		100		Ω	
Differential Data Input Amplitude		150		1200	mV _{pp}	Internally AC coupled
Output Data Rate			10.3125	10.5	Gb/s	
Differential Output Impedance	R _{out}		100		Ω	
Differential Data Output Amplitude		350	600	700	mV _{pp}	Internally AC coupled
Low-Speed Signal (LVTTTL) Interface Specification						
Input High Voltage		2.0		V _{cc} +0.3	V	
Input Low Voltage		GND		0.8	V	
Output High Voltage		2.4		V _{cc}	V	
Output Low Voltage		GND		0.5	V	

LINK LENGTH

Data Rate	Fiber Type	Model Bandwidth @ 1310nm (MHz-km)	Symbol	Min.	Typ.	Max.	Units
10.3 GBd	62.5/125 μm MMF (FDDI)	160	L _{max}			220	m
	62.5/125 μm MMF (OM1)	200				220	
	50/125 μm MMF (OM2)	500				220	
	50/125 μm MMF (OM3)	2000				220	

CONNECTION DIAGRAM

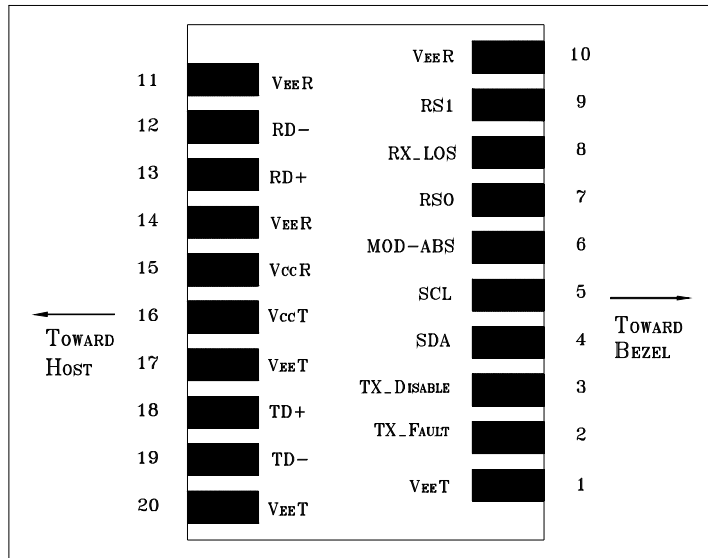

PIN	Signal Name	Description	PIN	Signal Name	Description
1	V _{EE} T	Transmitter Signal Ground	11	V _{EE} R	Receiver Signal Ground
2	TX_Fault	Transmitter Fault Indication. Logic "1" Output = Laser Fault. Logic "0" Output = Normal Operation	12	RD-	Inverse Receiver Data Out
3	TX_Disable	Logic "1" Input (or no connection) = TX off, Logic "0" = TX on.	13	RD+	Receiver Data Out
4	SDA	Modulation Definition 2 – Two wires serial ID Interface	14	V _{EE} R	Receiver Signal Ground
5	SDL	Modulation Definition 1 – Two wires serial ID Interface	15	V _{CC} R	Receiver Power – 3.3V±5%
6	MOD-ABS	Modulation Absent, connected to V _{EE} T or V _{EE} R in the module.	16	V _{CC} T	Transmitter Power – 3.3V±5%
7	RS0	RX Rate Select (LVTTTL). This pin has an internal 30k pulldown to ground. A signal on this pin will not affect module performance.	17	V _{EE} T	Transmitter Signal Ground
8	RX_LOS	Loss of Signal Out (OC).	18	TD+	Transmitter Data In
9	RS1	TX Rate Select (LVTTTL). This pin has an internal 30k pulldown to ground. A signal on this pin will not affect module performance.	19	TD-	Inverse Transmitter Data In
10	V _{EE} R	Receiver Signal Ground	20	V _{EE} T	Transmitter Signal Ground

MODULE DEFINITION

Module Definition	PIN 4	PIN 5	PIN 6	Interpretation by Host
4	SDA	SCL	MOD-ABS	Serial module definition protocol

Module Definition 4 specifies a serial definition protocol. For this definition, upon power up, SDA and SDL appear as no connector (NC) and MOD-ABS is TTL LOW. When the host system detects this condition, it activates the serial protocol. The protocol uses the 2-wire serial CMOS E²PROM protocol of the ATMEL AT24C01A/02/04 family of components.

RECOMMENDED CIRCUIT SCHEMATIC

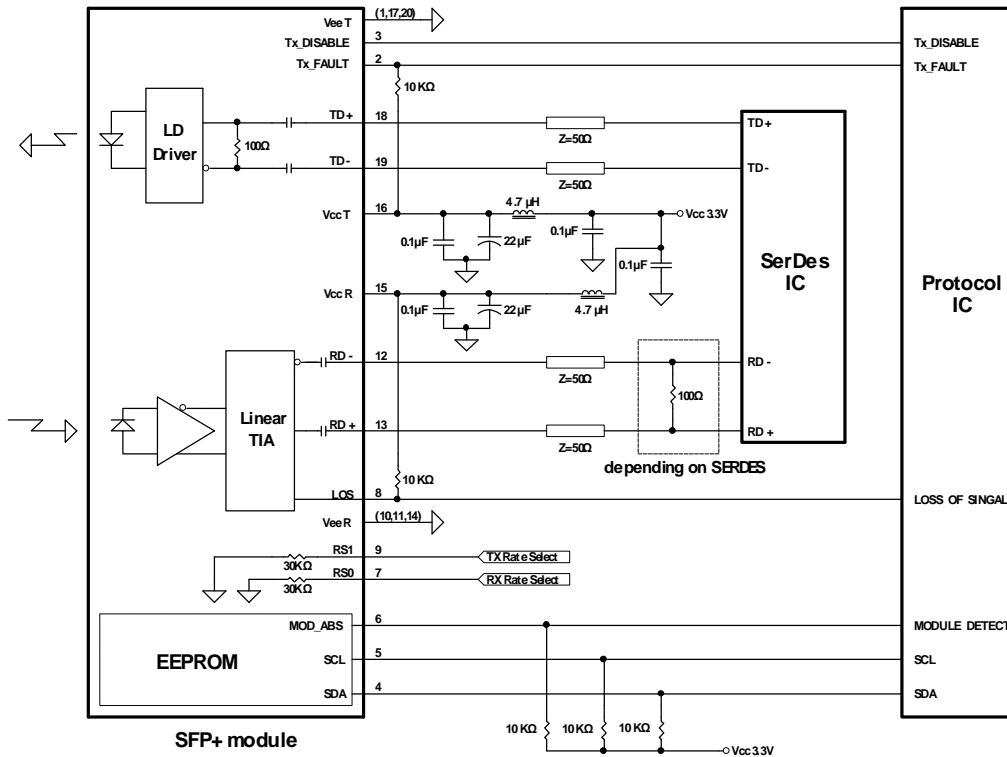

PACKAGE DIAGRAM

Units in mm

Top View

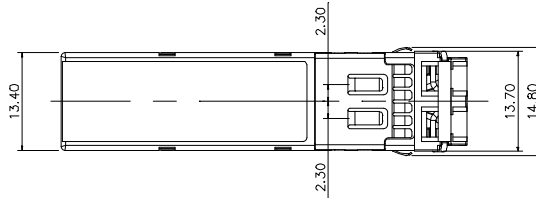

Front View

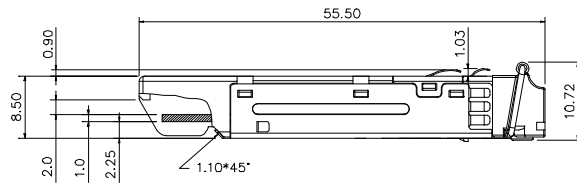

LATCH COLOR
BLACK: MM

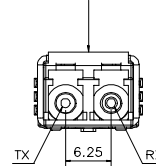

Side View

Bottom View

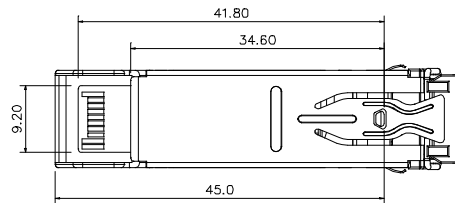

Note: Specifications subject to change without notice.

REVISION HISTORY

Version	Subject	Release Date
1.0	Initial datasheet	2008/8/1
